



European Cup Cadets Zagreb 2015

Zagreb (CRO) 14-15 February 2015

-55 kg

47 Judoka

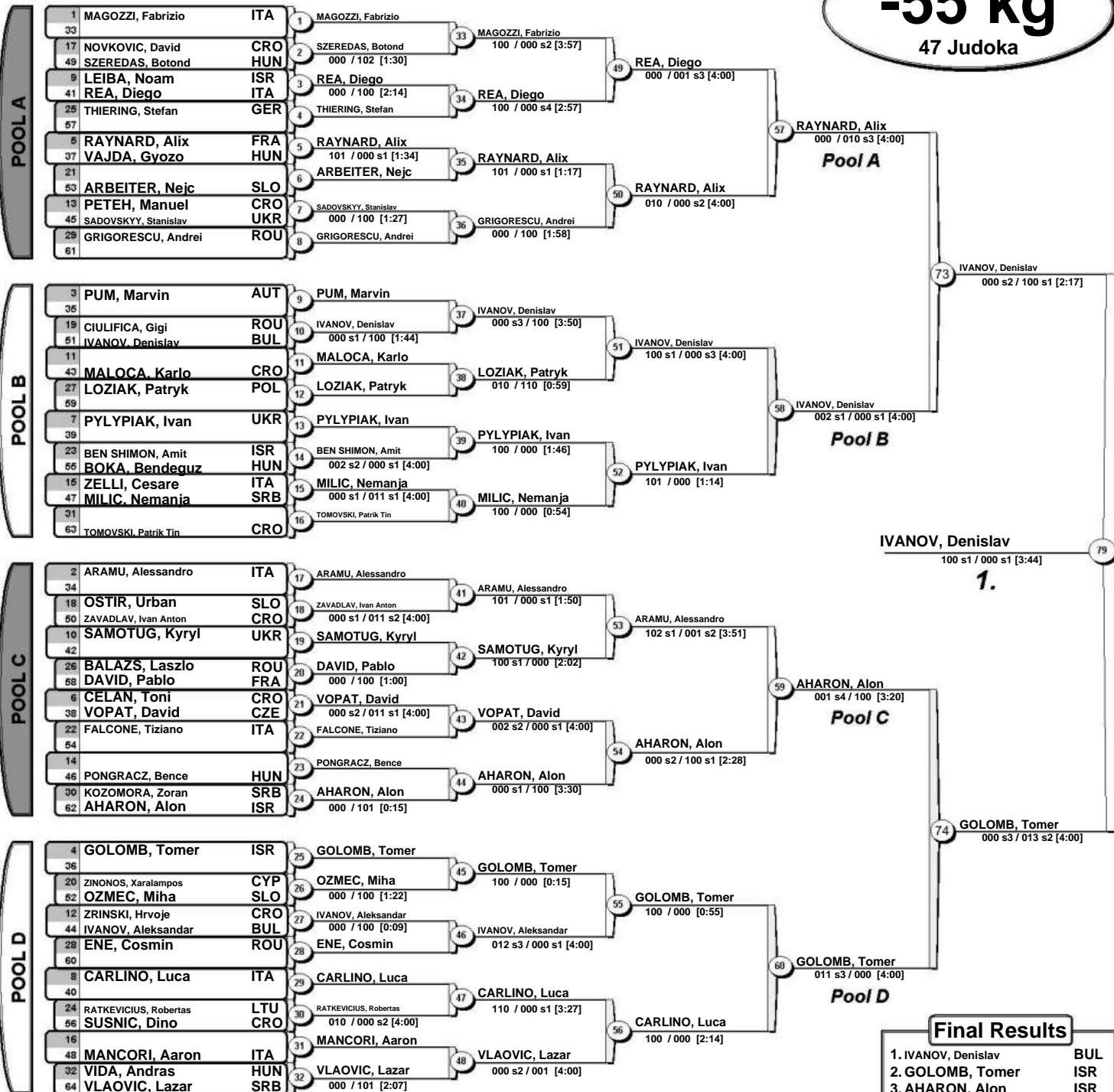

Repechage

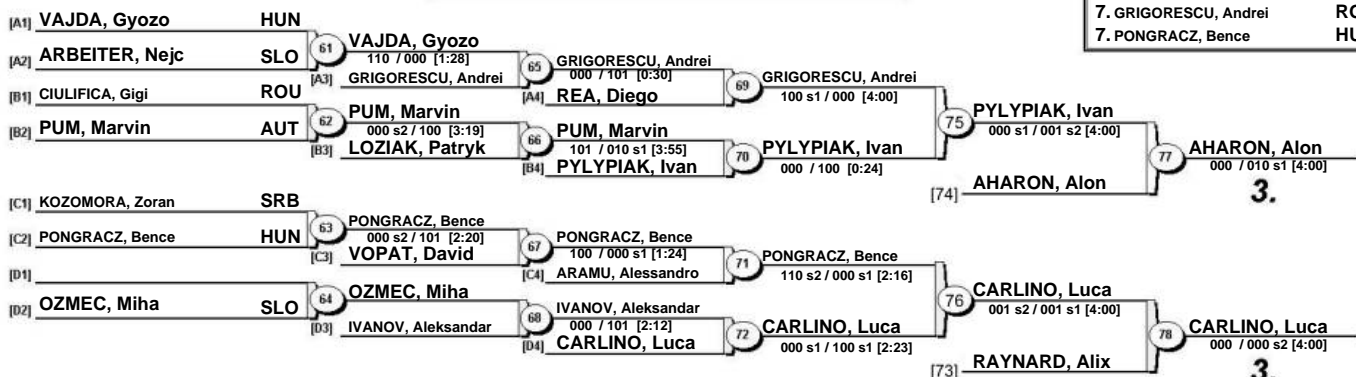



European Cup Cadets Zagreb 2015

Zagreb (CRO) 14-15 February 2015

-60 kg

62 Judoka

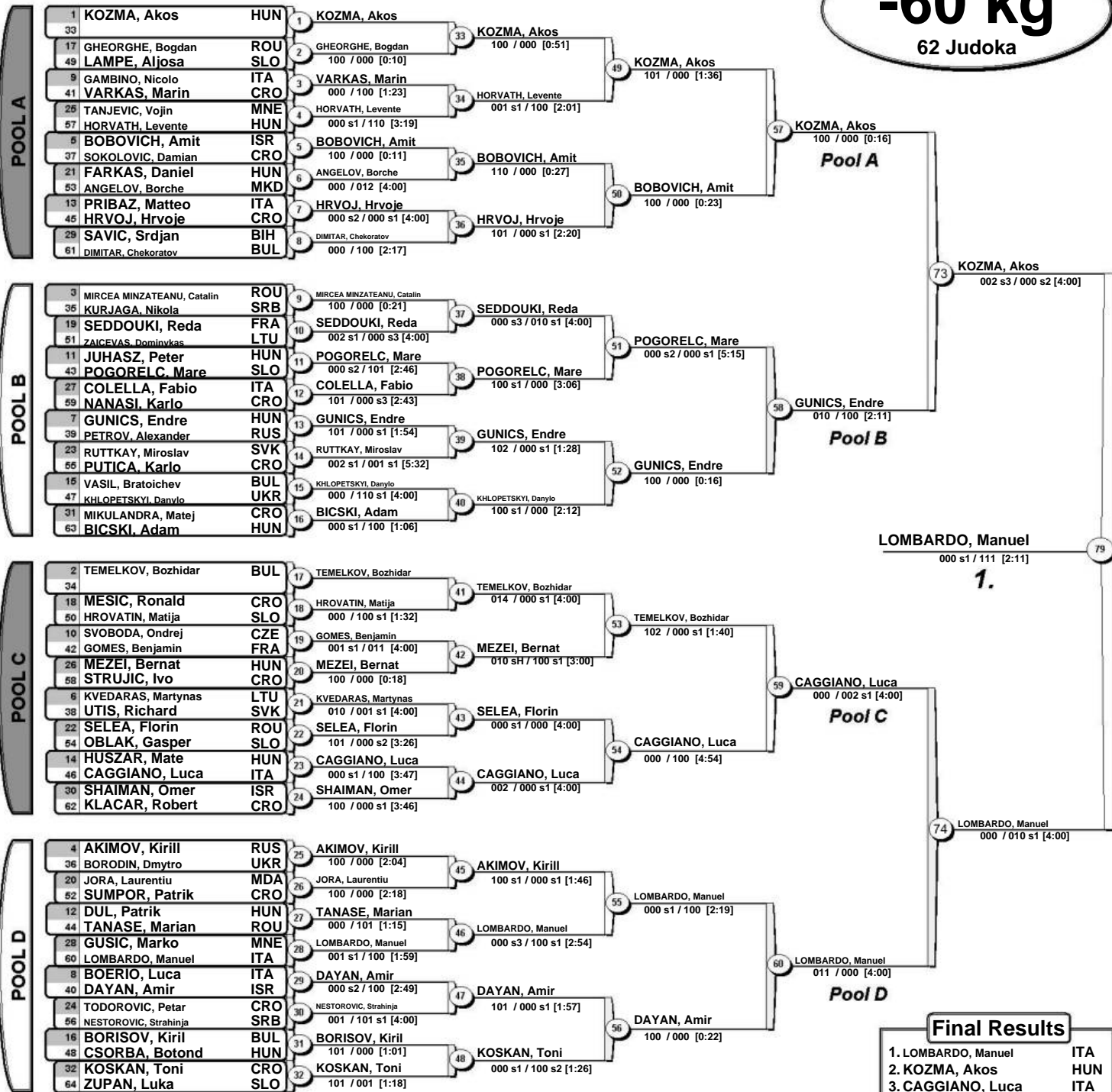



European Cup Cadets Zagreb 2015

Zagreb (CRO) 14-15 February 2015

A/B

-66 kg
82 Judoka

POOL A

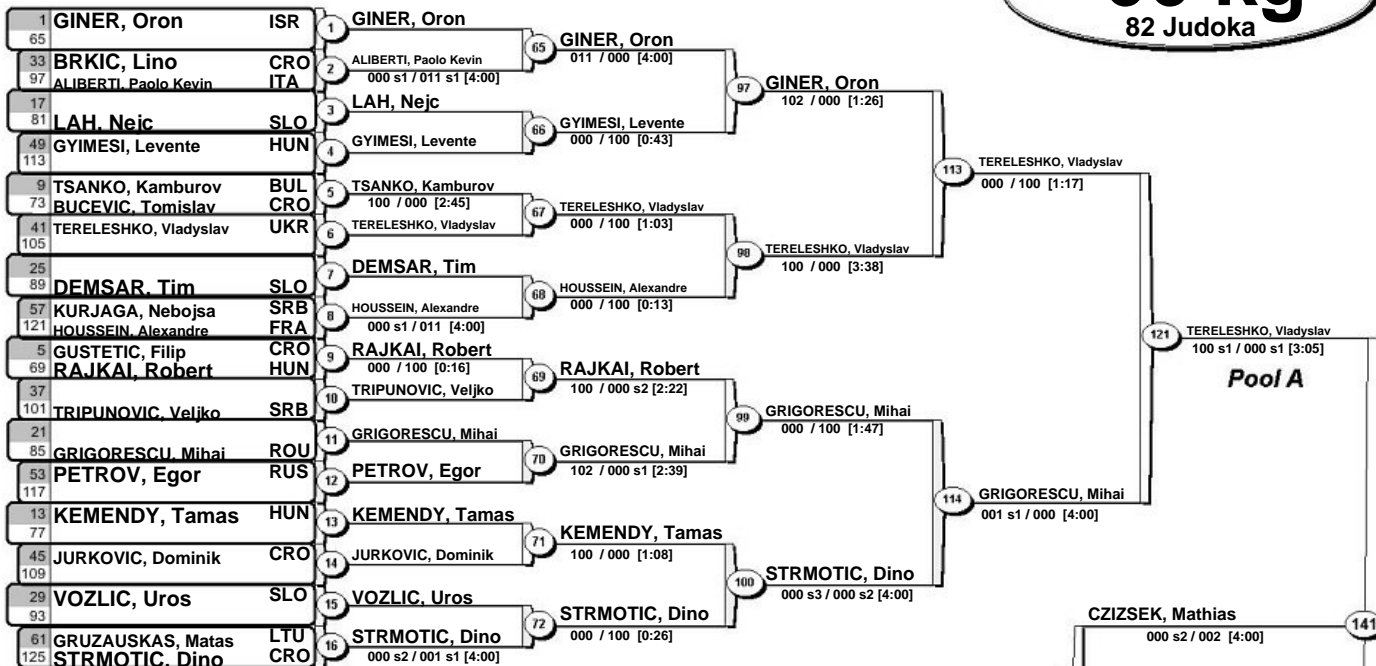

POOL B

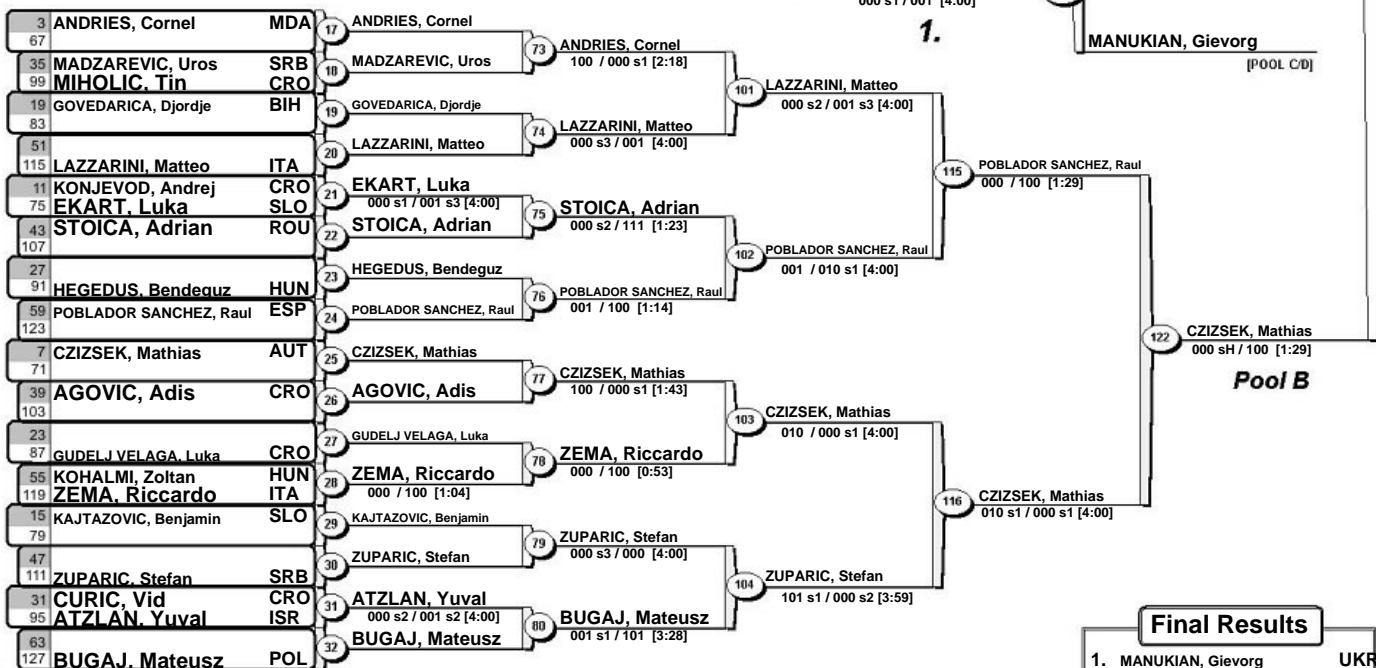

Final Results	
1.	MANUKIAN, Gievorg (UKR)
2.	CZIZSEK, Mathias (AUT)
3.	JURKOVIC, Ivo (SLO)
3.	TSIUKH, Dmytro (UKR)
5.	GRIGORESCU, Mihai (ROU)
5.	TERELESHKO, Vladyslav (UKR)
7.	ZEMA, Riccardo (ITA)
7.	GABUN, Constantin (MDA)

Repechage

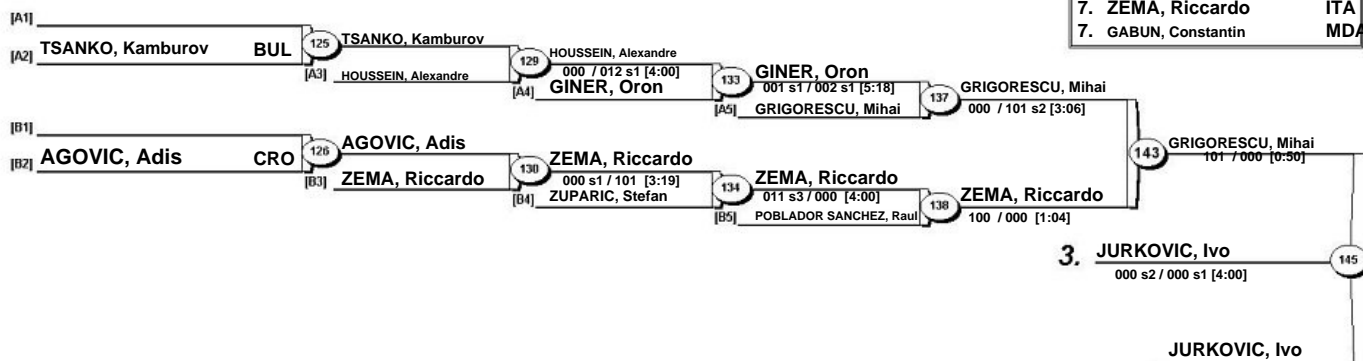



European Cup Cadets Zagreb 2015

Zagreb (CRO) 14-15 February 2015

-73 kg

56 Judoka

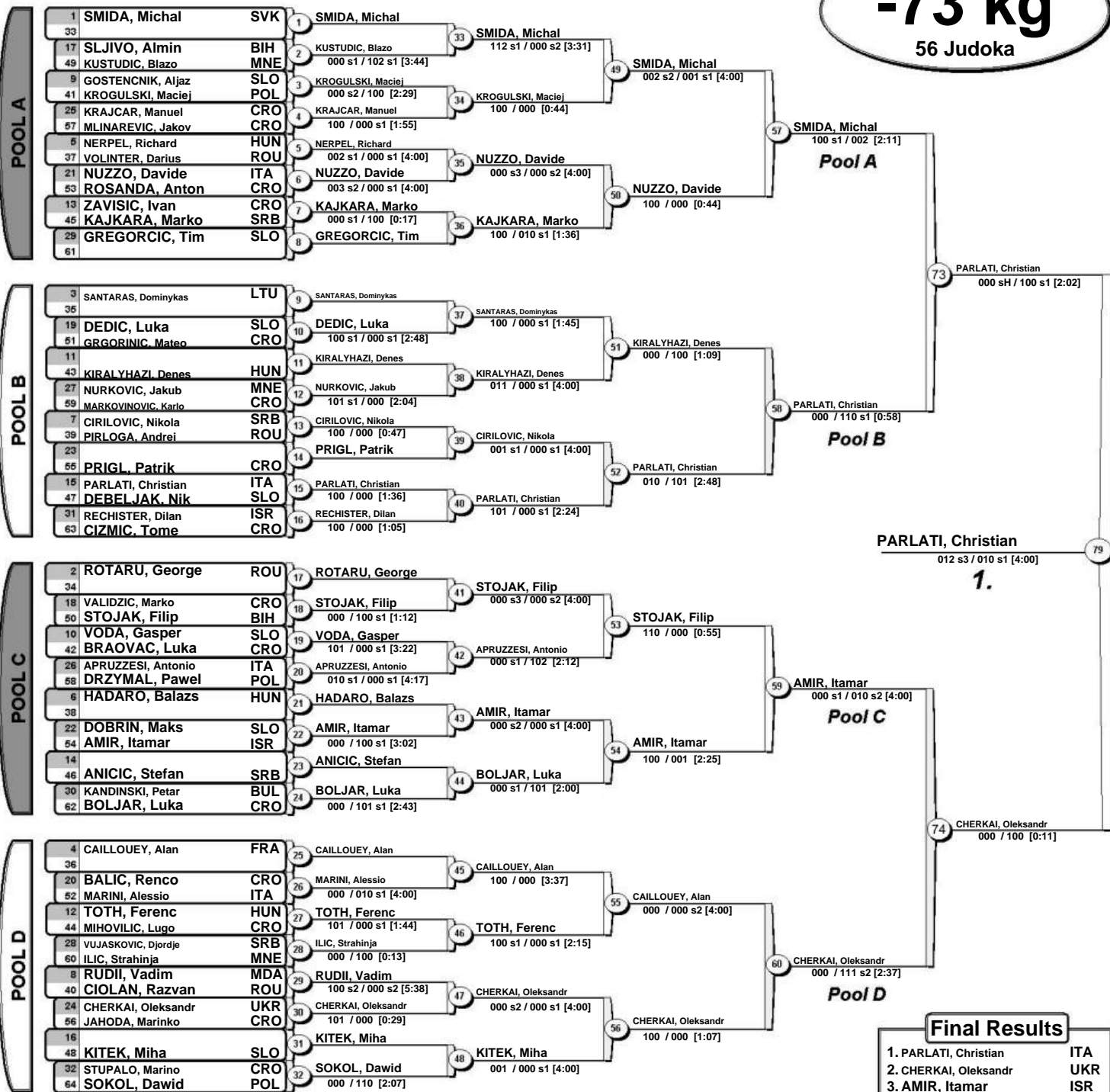

Repechage

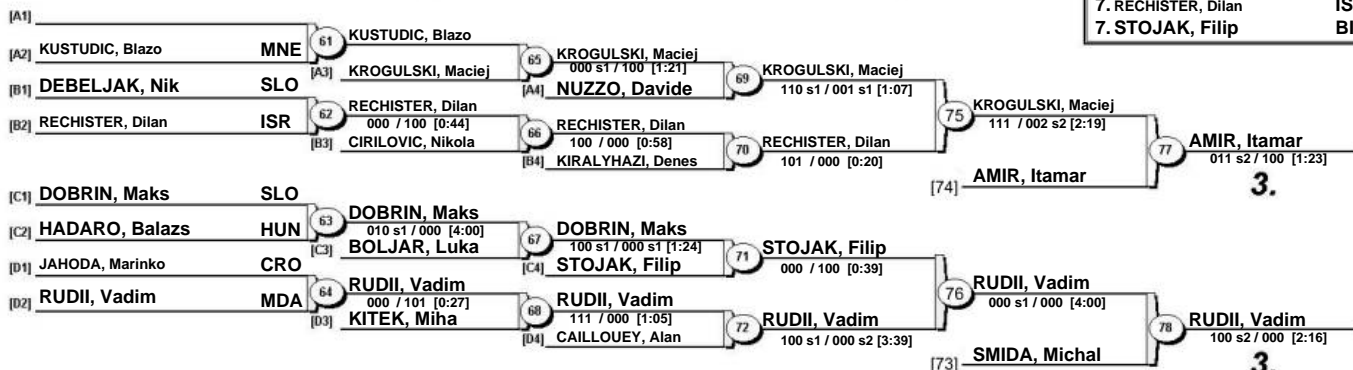



European Cup Cadets Zagreb 2015

Zagreb (CRO) 14-15 February 2015

-81 kg

34 Judoka

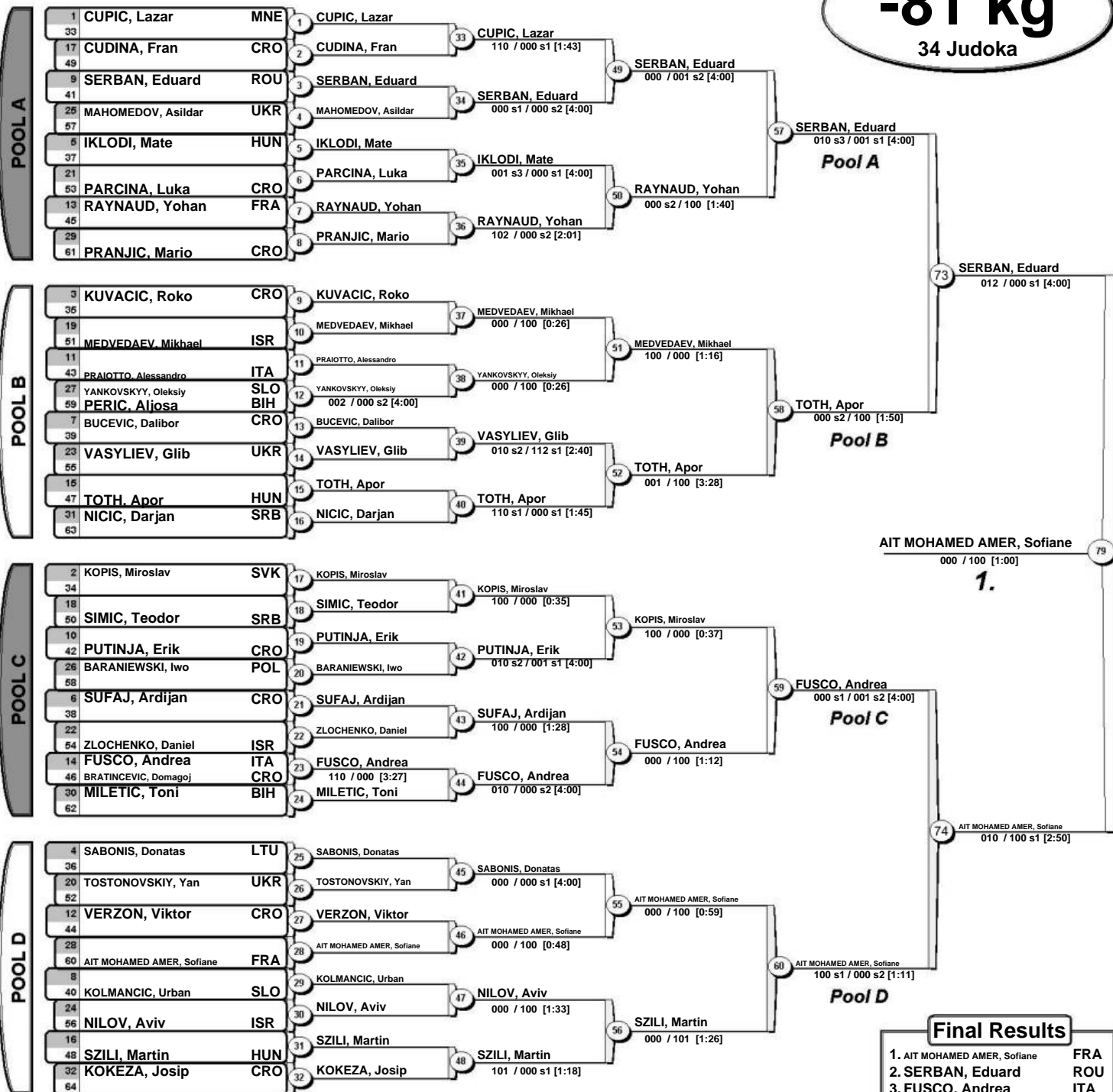

Repechage

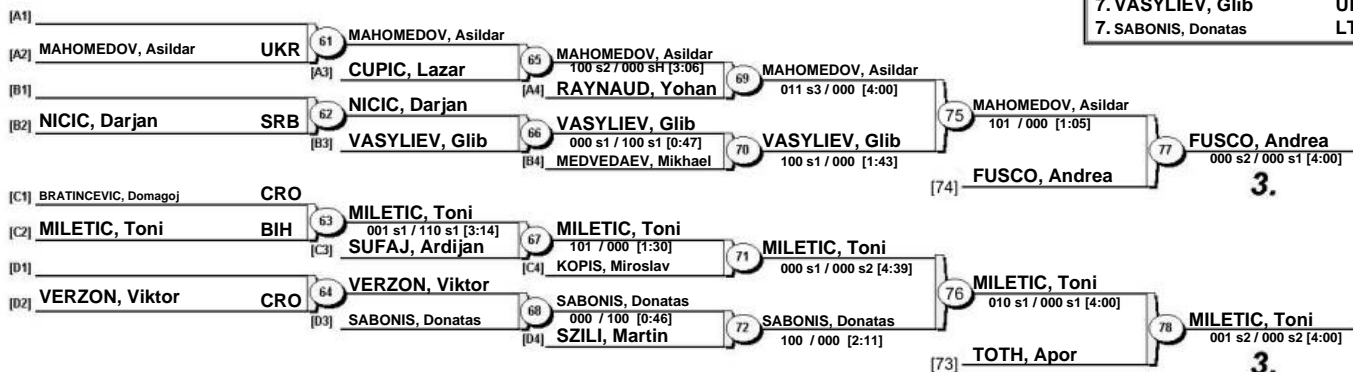



European Cup Cadets Zagreb 2015

Zagreb (CRO) 14-15 February 2015

-90 kg

26 Judoka

POOL A

1	KMIELIAUSKAS, Antanas	LTU	1	KMIELIAUSKAS, Antanas
17			17	KMIELIAUSKAS, Antanas
9	BERBATTI, Stefano	ITA	2	BERBATTI, Stefano
25	GERL KORENC, Jan	SLO	2	100 / 000 s1 [2:15]
5	KOVACEVIC, Vasilije	SRB	3	HRISTOV, Hristo
21	HRISTOV, Hristo	BUL	3	000 / 100 s1 [2:48]
13	TOTH, Csaba	HUN	4	TOTH, Csaba
29			4	

25 HRISTOV, Hristo
000 / 100 [1:24]
Pool A - Winner
Vainqueur / Sieger

POOL B

3	DEVOS, Paul	FRA	5	DEVOS, Paul
19	RYCIAK, Eryk	POL	5	100 s1 / 010 sH [1:46]
11	LOUZOUN, Almog	ISR	6	LOUZOUN, Almog
27	KURAK, Lukas	SVK	6	101 s1 / 001 s1 [3:18]
7	BRASNOVIC, Darko	SRB	7	BRASNOVIC, Darko
23	MILOSEVIC, Damjan	CRO	7	110 / 000 s3 [3:34]
15			8	GALAMBOS, Milan
31	GALAMBOS, Milan	HUN	8	

19 DEVOS, Paul
110 / 000 s1 [2:06]

26 DEVOS, Paul
110 s2 / 001 [2:45]
Pool B - Winner
Vainqueur / Sieger

POOL C

2	MICIC, Stefan	SRB	9	MICIC, Stefan
18			9	
10	RUIMI, Ziv	ISR	10	RUIMI, Ziv
26	KEJZA, Pawel	POL	10	010 s2 / 000 s1 [4:00]
6			11	MELIS, Stefano
22	MELIS, Stefano	ITA	11	
14			12	BABENKO, Oleksii
30	BABENKO, Oleksii	UKR	12	

21 MICIC, Stefan
100 / 000 [1:16]

27 BABENKO, Oleksii
000 s1 / 100 [1:59]
Pool C - Winner
Vainqueur / Sieger

POOL D

4	SCHNEIDER, Sebastian	AUT	13	SCHNEIDER, Sebastian
20			13	
12	PRAGLIOLA, Francesco	ITA	14	HORVAT, Jan
28	HORVAT, Jan	SLO	14	000 / 100 [0:30]
8	GACESA, Luka	SRB	15	GACESA, Luka
24	VAKALAS, Aidan	LTU	15	100 / 001 [1:26]
16	ARVAI, Peter	HUN	16	THOME, Dorian
32	THOME, Dorian	FRA	16	011 s2 / 111 [3:58]

23 HORVAT, Jan
000 / 100 s1 [1:03]

28 HORVAT, Jan
100 / 000 [0:35]
Pool D - Winner
Vainqueur / Sieger

BABENKO, Oleksii

000 / 101 [0:52]

1.

38 BABENKO, Oleksii
101 / 000 [0:18]

Results

Résultat / Platzierungen

1. BABENKO, Oleksii UKR
2. DEVOS, Paul FRA
3. KMIELIAUSKAS, Antanas LTU
3. MICIC, Stefan SRB
5. HORVAT, Jan SLO
5. HRISTOV, Hristo BUL
7. LOUZOUN, Almog ISR
7. SCHNEIDER, Sebastian AUT

Repechage / Trostrunde

[A1]	KOVACEVIC, Vasilije	SRB	29	KOVACEVIC, Vasilije
[A2]	TOTH, Csaba	HUN	29	110 s2 / 000 [2:43]
[B1]	RYCIAK, Eryk	POL	[A3]	KMIELIAUSKAS, Antanas
[B2]	LOUZOUN, Almog	ISR	30	LOUZOUN, Almog
[C1]			[B3]	BRASNOVIC, Darko
[C2]	MELIS, Stefano	ITA	31	MELIS, Stefano
[D1]	PRAGLIOLA, Francesco	ITA	[C3]	MICIC, Stefan
[D2]	SCHNEIDER, Sebastian	AUT	32	SCHNEIDER, Sebastian
			[D3]	THOME, Dorian

33 KMIELIAUSKAS, Antanas
000 s1 / 101 s1 [2:03]

39 KMIELIAUSKAS, Antanas
111 / 000 s1 [2:15]

41 KMIELIAUSKAS, Antanas
000 s1 / 000 s2 [4:00]

38 HORVAT, Jan

3. 3.

35 MICIC, Stefan
000 / 110 [0:24]

40 MICIC, Stefan
110 / 000 [0:23]

42 MICIC, Stefan
100 / 000 s1 [2:31]

37 HRISTOV, Hristo

3.



European Cup Cadets Zagreb 2015

Zagreb (CRO) 14-15 February 2015

+90 kg

15 Judoka

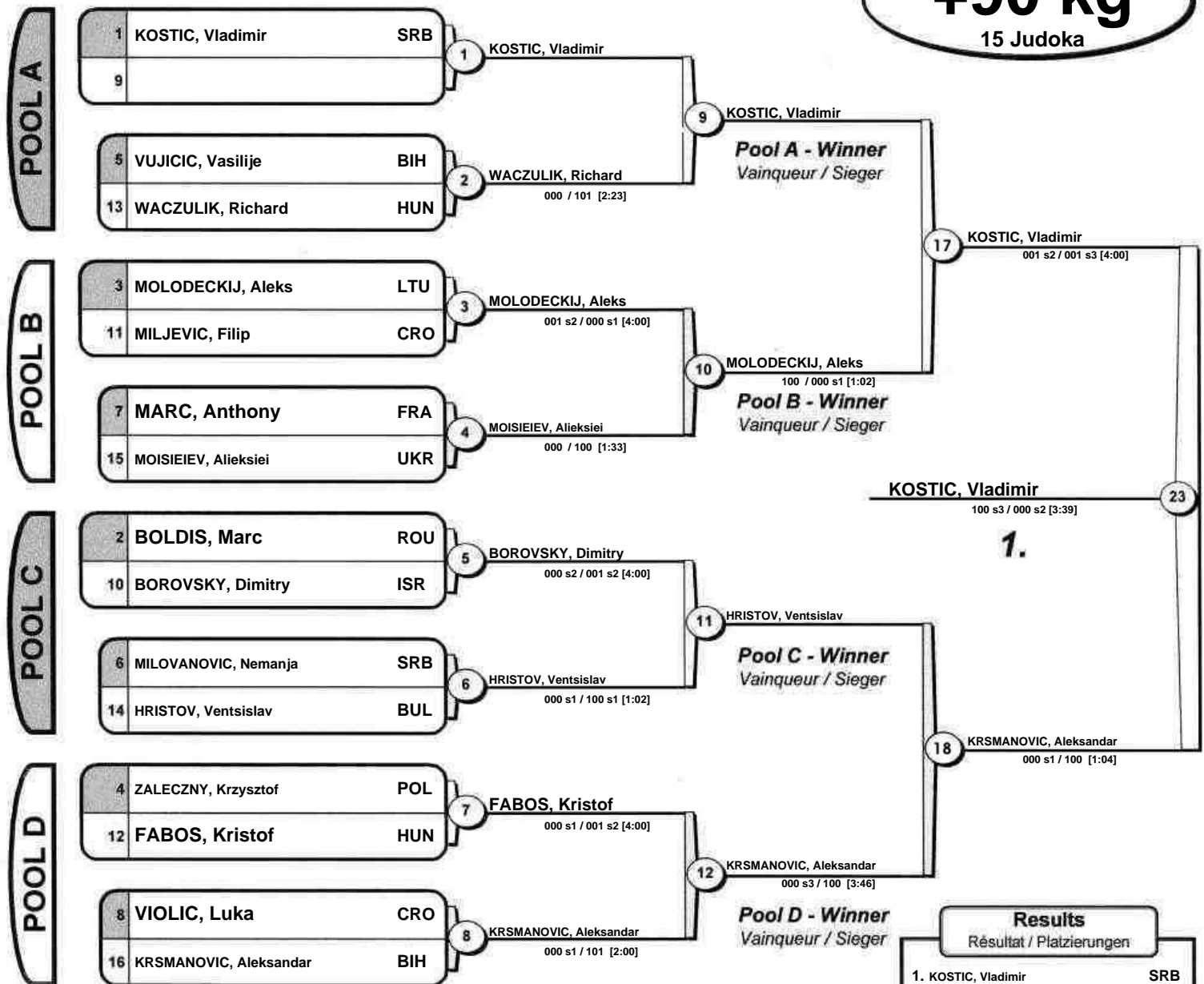

KOSTIC, Vladimir

100 s3 / 000 s2 [3:39]

1.

Results

Résultat / Platzierungen

1. KOSTIC, Vladimir	SRB
2. KRSMANOVIC, Aleksandar	BIH
3. MOISIEIEV, Alieksiei	UKR
3. FABOS, Kristof	HUN
5. HRISTOV, Ventsislav	BUL
5. MOLODECKIJ, Aleks	LTU
7. WACZULIK, Richard	HUN
7. BOROVSKY, Dimitry	ISR

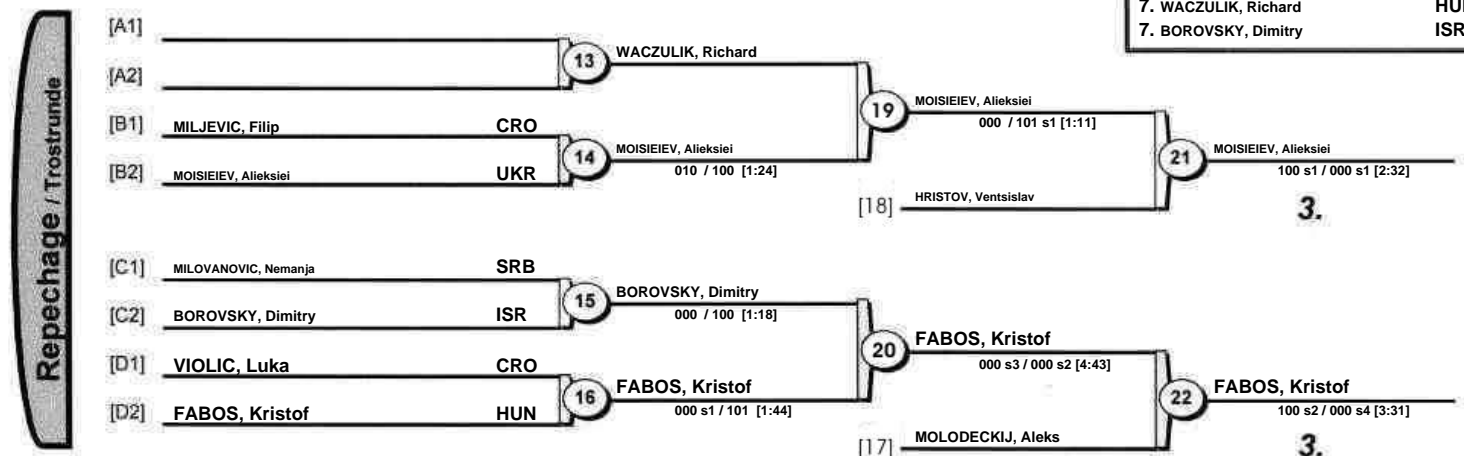



European Cup Cadets Zagreb 2015

Zagreb (CRO) 14-15 February 2015

-40 kg
4 Judoka

			1	2	3	4			
1	SIVKOVA, Boyana	BUL		-	+	+	2		
					(10)	(100)	(110)		
2	LAROCHE, Cassandra	FRA	+		+	+	3		
			(100)		(100)	(100)	(300)		
3	TRINA, Sara	ITA	-	-		+	1		
						(0.5)	(0.5)		
4	SEMENIUK, Alona	UKR	-	-	-		(0)		

1 SIVKOVA, Boyana BUL 1 LAROCHE, Cassandra FRA
2 LAROCHE, Cassandra FRA 000 / 100 [0:55]

3 TRINA, Sara ITA 2 TRINA, Sara ITA
4 SEMENIUK, Alona UKR 000 / 000 s3 [4:00]

1 SIVKOVA, Boyana BUL 3 SIVKOVA, Boyana BUL
3 TRINA, Sara ITA 011 s1 / 000 s1 [4:00]

2 LAROCHE, Cassandra FRA 4 LAROCHE, Cassandra FRA
4 SEMENIUK, Alona UKR 100 / 000 [0:19]

1 SIVKOVA, Boyana BUL 5 SIVKOVA, Boyana BUL
4 SEMENIUK, Alona UKR 100 s1 / 000 s1 [1:06]

2 LAROCHE, Cassandra FRA 6 LAROCHE, Cassandra FRA
3 TRINA, Sara ITA 100 / 000 [0:27]

Final Results

1. LAROCHE, Cassandra FRA
2. SIVKOVA, Boyana BUL
3. TRINA, Sara ITA



European Cup Cadets Zagreb 2015

Zagreb (CRO) 14-15 February 2015

-44 kg

17 Judoka

POOL A

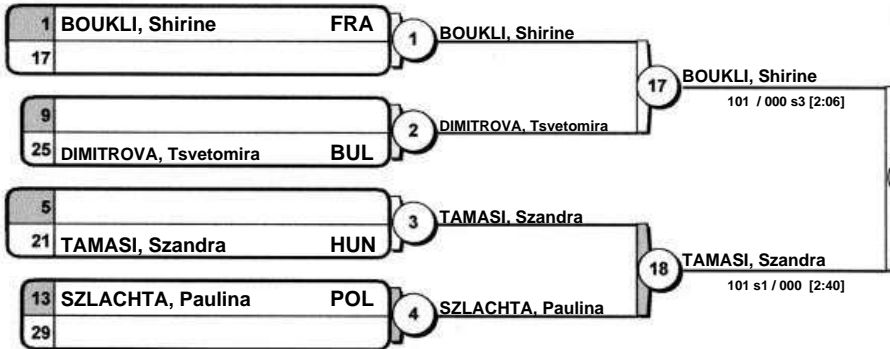

POOL B

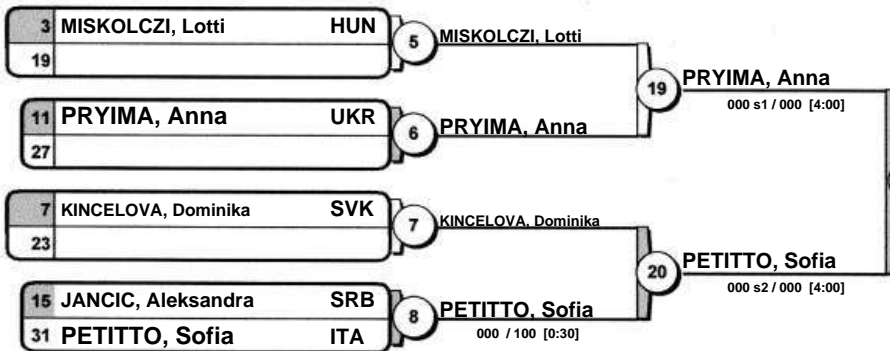

POOL C



POOL D



BILODID, Daria

001 / 101 s1 [3:58]

1.

BILODID, Daria
000 s2 / 002 s2 [4:00]

Results Résultat / Platzierungen

1. BILODID, Daria UKR
2. BOUKLI, Shirine FRA
3. PIECHOTA, Olivia GBR
3. PETITTO, Sofia ITA
5. KINCELOVA, Dominika SVK
5. IONITA, Georgiana ROU
7. TAMASI, Szandra HUN
7. MERCNIK, Ljudmila SLO

Repechage / Trostrunde

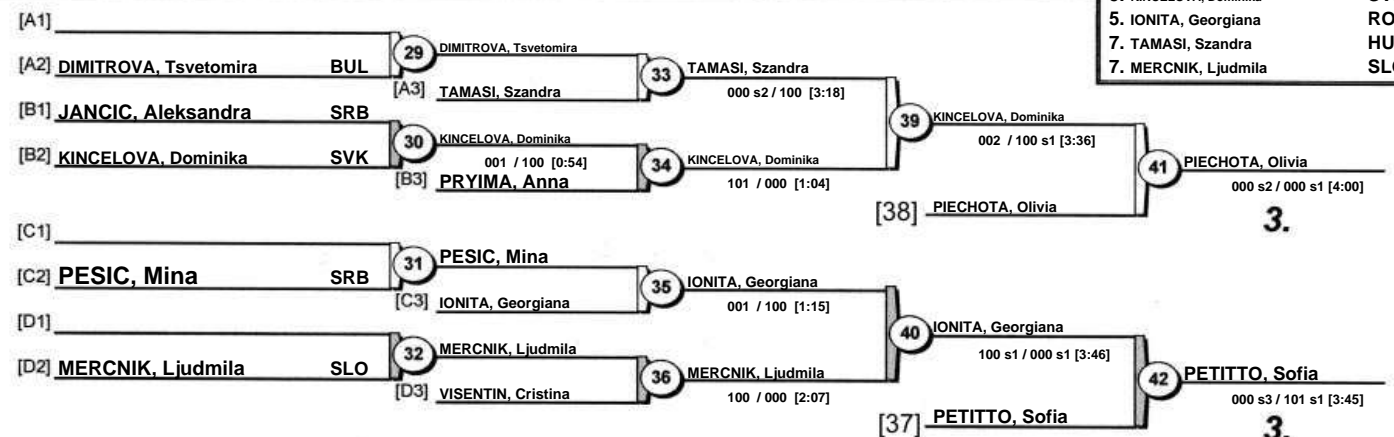

3.

3.



European Cup Cadets Zagreb 2015

Zagreb (CRO) 14-15 February 2015

-48 kg

31 Judoka

POOL A

1	STANGAR, Marusa	SLO	1	STANGAR, Marusa
17				
9	ZARKOVIC, Martina	CRO	2	STOJADINOV, Andrea
25	STOJADINOV, Andrea	SRB		000 / 100 [0:43]
5	PALYVODA, Anzhelika	UKR	3	KOPASZ, Fanni
21	KOPASZ, Fanni	HUN		000 s1 / 100 [1:50]
13	SORMAZ, Vanja	BIH	4	MARCUS TABELLION, Coraline
29	MARCUS TABELLION, Coraline	FRA		000 / 100 [0:18]
			18	MARCUS TABELLION, Coraline
				000 s1 / 100 [2:03]

25 STANGAR, Marusa
101 / 000 [3:18]
Pool A - Winner
Vainqueur / Sieger

POOL B

3	MIHALOVITS, Kincso	HUN	5	MIHALOVITS, Kincso
19	BRANKOVIC, Barbara	CRO		100 / 000 [0:41]
11	SABLIEVA, Kateryna	UKR	6	KROPSKA, Natalia
27	KROPSKA, Natalia	POL		000 s2 / 001 s1 [4:00]
7	SANTINI, Giulia	ITA	7	SANTINI, Giulia
23	CHATZIASTROS, Lena	GER		101 / 000 [1:14]
15	IVKOVIC, Marija	SRB	8	IVKOVIC, Marija
31	FARINA, Veronica	ITA		100 s1 / 000 [3:01]
			20	IVKOVIC, Marija
				000 / 100 s2 [3:38]

26 MIHALOVITS, Kincso
100 / 000 [1:25]
Pool B - Winner
Vainqueur / Sieger

POOL C

2	PONT, Blandine	FRA	9	PONT, Blandine
18	BRKIC, Ana Marija	BIH		101 / 000 s1 [1:25]
10	BOCCOLA, Rossella	ITA	10	PETROVIC, Nadezda
26	PETROVIC, Nadezda	SRB		000 / 100 [1:02]
6	MLINARIC, Margareta	CRO	11	ZACHOVA, Renata
22	ZACHOVA, Renata	CZE		001 s1 / 001 [4:32]
14	BULASHEVYCH, Mariia	UKR	12	MAROTI, Alexandra
30	MAROTI, Alexandra	HUN		000 s1 / 001 s1 [4:32]
			22	MAROTI, Alexandra
				000 s3 / 001 s1 [4:00]

27 PONT, Blandine
100 / 000 s3 [3:39]
Pool C - Winner
Vainqueur / Sieger

POOL D

4	ZAMPONI, Martina	ITA	13	ZAMPONI, Martina
20	BRLETIC, Matea	CRO		111 / 000 [2:24]
12	RANC, Sasa	SLO	14	VASHCHENKO, Lidiya
28	VASHCHENKO, Lidiya	UKR		000 s1 / 102 s1 [3:47]
8	VUKOVIC, Marija	SRB	15	VUKOVIC, Marija
24	GRADISEK, Veronika	CRO		101 s1 / 000 s1 [1:40]
16	CASTAGNOLA, Martina	ITA	16	REXHEPI, Arbresha
32	REXHEPI, Arbresha	MKD		000 s1 / 100 [4:00]
			24	VUKOVIC, Marija
				100 / 000 sX [3:28]

28 ZAMPONI, Martina
011 / 010 [4:00]
Pool D - Winner
Vainqueur / Sieger

STANGAR, Marusa
110 / 000 [3:39]

1.

38 PONT, Blandine
100 s1 / 000 s1 [3:22]

Results Résultat / Platzierungen

- STANGAR, Marusa SLO
- PONT, Blandine FRA
- ZAMPONI, Martina ITA
- PETROVIC, Nadezda SRB
- KROPSKA, Natalia POL
- MIHALOVITS, Kincso HUN
- STOJADINOV, Andrea SRB
- VUKOVIC, Marija SRB

Repechage / Trostrunde

[A1]			29	STOJADINOV, Andrea	33	STOJADINOV, Andrea
[A2]	STOJADINOV, Andrea	SRB				002 / 000 [1:14]
[B1]	BRANKOVIC, Barbara	CRO	[A3]	MARCUS TABELLION, Coraline		
[B2]	KROPSKA, Natalia	POL	30	KROPSKA, Natalia	34	KROPSKA, Natalia
				000 / 100 [0:07]		000 s1 / 100 [1:28]
			[B3]	IVKOVIC, Marija		100 / 000 [1:05]
[C1]	BRKIC, Ana Marija	BIH			38	ZAMPONI, Martina
[C2]	PETROVIC, Nadezda	SRB	31	PETROVIC, Nadezda	35	PETROVIC, Nadezda
				000 / 100 [1:32]		000 / 000 s1 [4:39]
			[C3]	MAROTI, Alexandra		
[D1]	BRLETIC, Matea	CRO			40	PETROVIC, Nadezda
[D2]	VASHCHENKO, Lidiya	UKR	32	BRLETIC, Matea		100 / 000 [0:47]
				000 s1 / 000 s2 [4:00]		
			[D3]	VUKOVIC, Marija	36	VUKOVIC, Marija
						000 s1 / 100 s1 [1:26]
					37	MIHALOVITS, Kincso
						100 / 001 [1:19]

3.

3.



European Cup Cadets Zagreb 2015

Zagreb (CRO) 14-15 February 2015

-52 kg

31 Judoka

POOL A

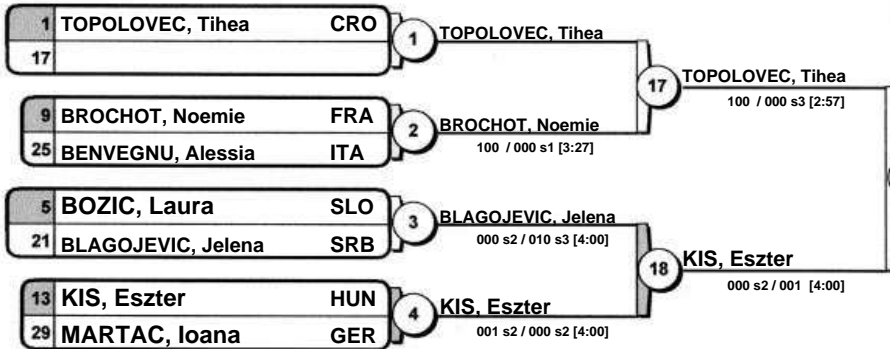

Pool A - Winner
Vainqueur / Sieger

POOL B

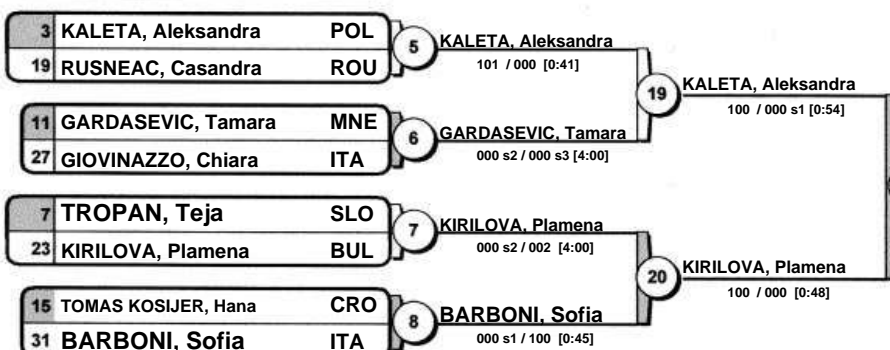

Pool B - Winner
Vainqueur / Sieger

POOL C

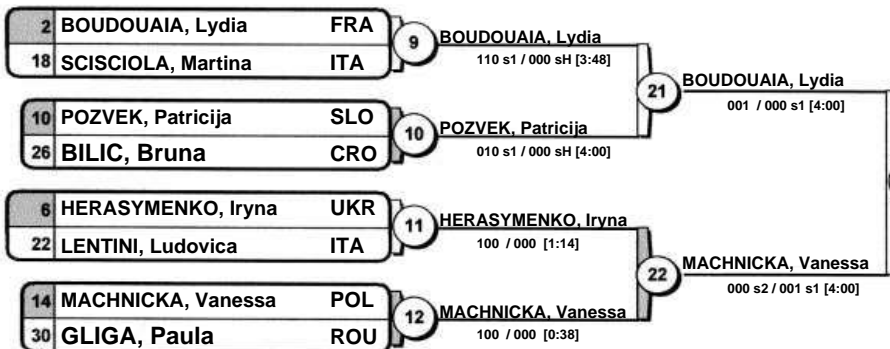

Pool C - Winner
Vainqueur / Sieger

POOL D

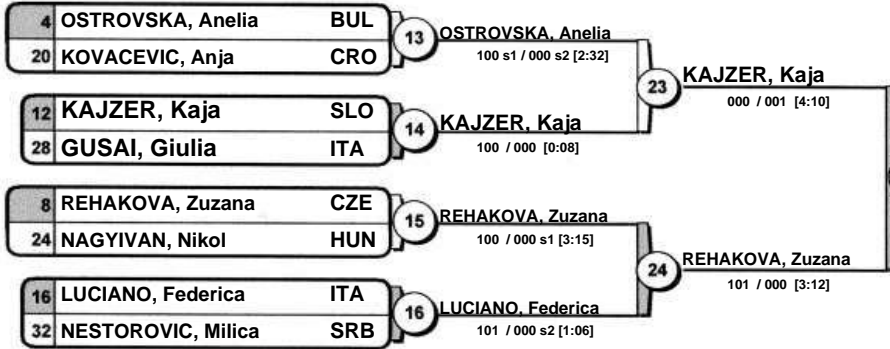

Pool D - Winner
Vainqueur / Sieger

TOPOLOVEC, Tihea

1.

KAJZER, Kaja

Results
Résultat / Platzierungen

- TOPOLOVEC, Tihea CRO
- KAJZER, Kaja SLO
- BOUDOUAIA, Lydia FRA
- KIRILOVA, Plamena BUL
- BROCHOT, Noemie FRA
- SCISCIOLA, Martina ITA
- TROPAN, Teja SLO
- OSTROVSKA, Anelia BUL

Repechage / Trostrunde

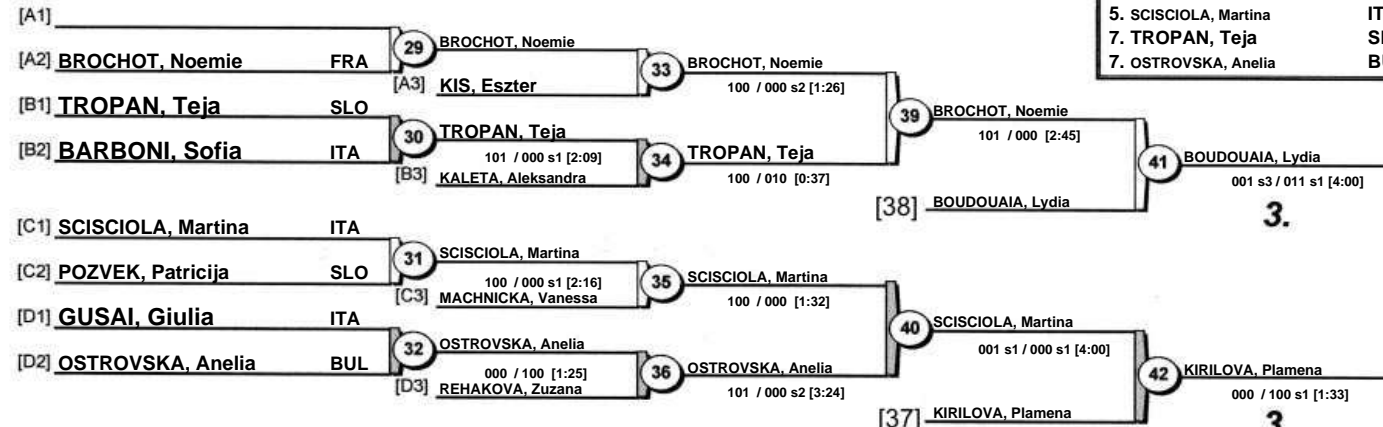

3.

3.



European Cup Cadets Zagreb 2015

Zagreb (CRO) 14-15 February 2015

-57 kg

45 Judoka

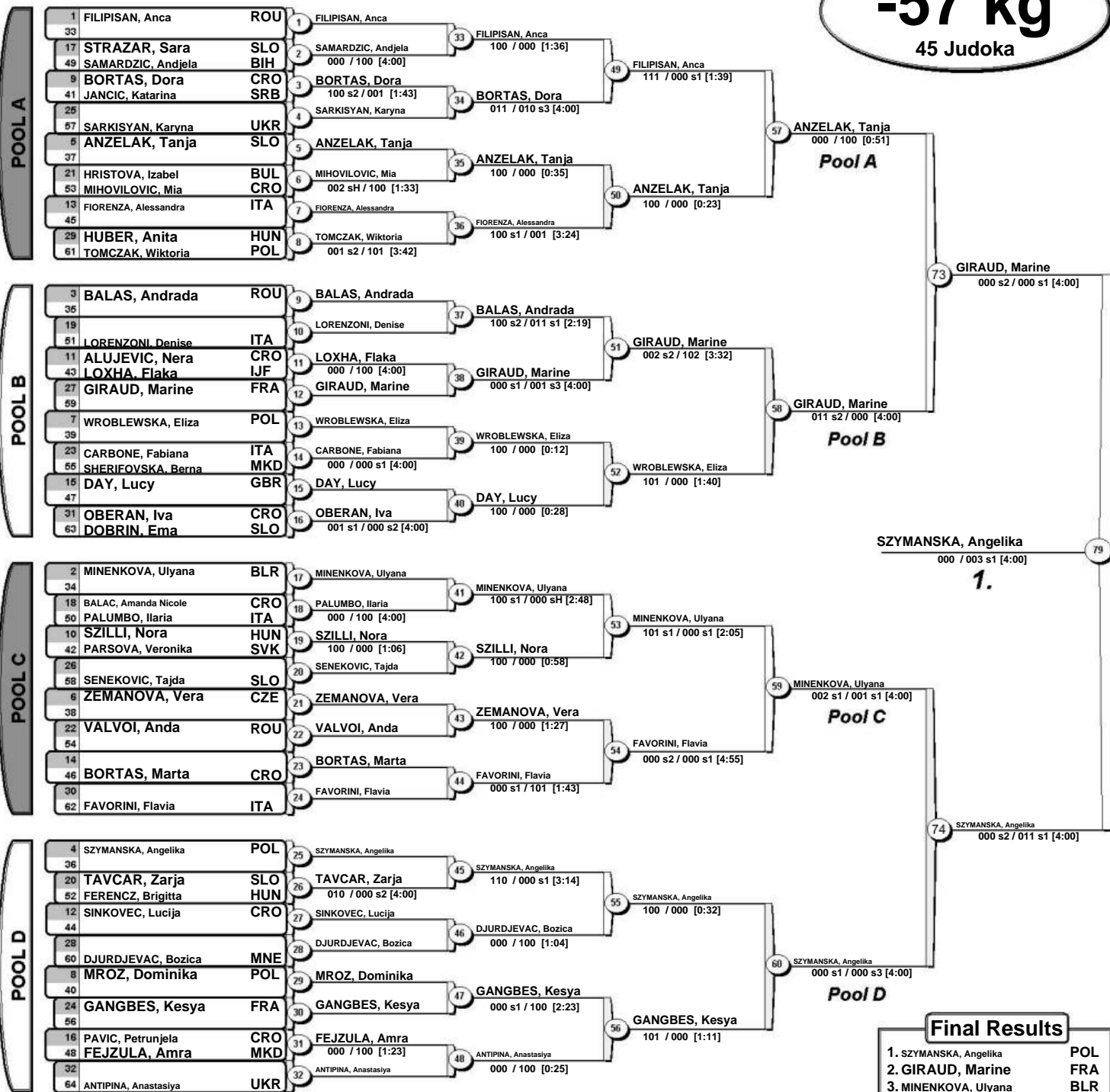

Repechage

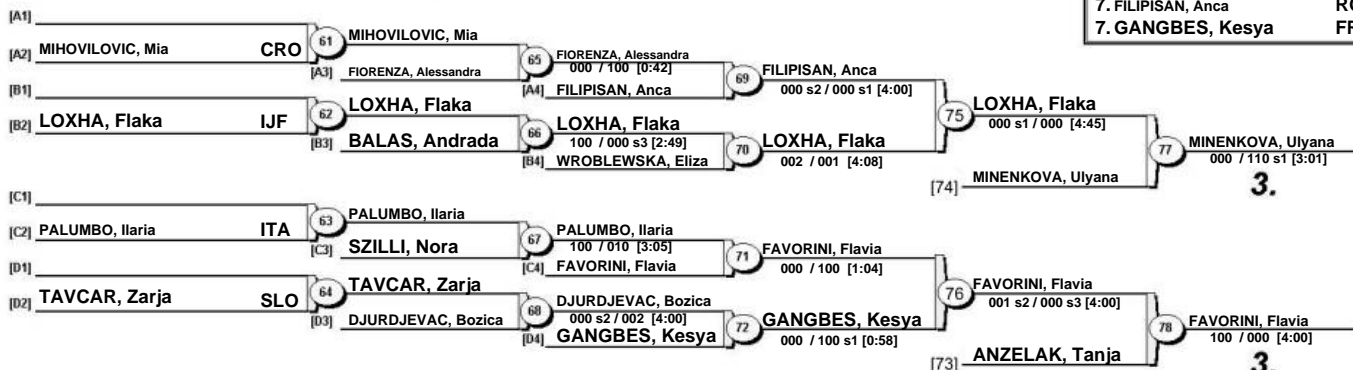



European Cup Cadets Zagreb 2015

Zagreb (CRO) 14-15 February 2015

-63 kg

32 Judoka

POOL A

1 MILIC, Mirjana	MNE	1 MILIC, Mirjana	100 / 000 [0:28]
17 BARSAN, Gabriela	ROU	17 MILIC, Mirjana	100 / 000 s1 [2:21]
9 SLATINSEK, Julija	SLO	2 KLIBA, Lara	000 / 012 s2 [4:00]
25 KLIBA, Lara	CRO	3 STUMPP, Tarah	101 / 000 s1 [2:03]
5 STUMPP, Tarah	GER	18 OBRADOVIC, Anja	000 / 100 [1:55]
21 KNEGO, Matea	CRO	4 OBRADOVIC, Anja	010 s2 / 000 [4:00]
13 OBRADOVIC, Anja	SRB	29 TONIOLO, Elisa	

25 OBRADOVIC, Anja
000 s1 / 000 [4:38]
Pool A - Winner
Vainqueur / Sieger

POOL B

3 LISONI, Chiara	ITA	5 LISONI, Chiara	100 / 000 s1 [1:03]
19 KOKORIC, Marta	CRO	19 LISONI, Chiara	011 s2 / 001 [4:00]
11 CSERVENAK, Anna	HUN	6 STOYANOVA, Iliana	000 s2 / 100 [2:19]
27 STOYANOVA, Iliana	BUL	7 D ISANTO, Nicolle	000 / 000 s3 [4:00]
7 D ISANTO, Nicolle	ITA	20 D ISANTO, Nicolle	000 s2 / 000 s3 [4:00]
23 KHRYASHCHEVSKA, Iryna	UKR	8 VEREPLA, Leila	000 / 100 [2:10]
15 KLIKOVAC, Bozana	MNE	31 VEREPLA, Leila	

26 LISONI, Chiara
100 s3 / 000 s3 [3:48]
Pool B - Winner
Vainqueur / Sieger

POOL C

2 KUKHARUK, Hanna	UKR	9 KUKHARUK, Hanna	002 s1 / 000 s1 [4:00]
18 PISKUNOVA, Darja	LTU	21 KUKHARUK, Hanna	101 / 000 [3:00]
10 VUKOVIC, Helena	CRO	10 SIMEOLI, Nadia	000 s1 / 101 [3:53]
26 SIMEOLI, Nadia	ITA	11 KUKIC, Ivana	000 s2 / 110 s2 [2:08]
6 LUNGU, Andra	ROU	22 SAID ERRHAMANI, Assia	000 s2 / 100 [1:02]
22 KUKIC, Ivana	BIH	12 SAID ERRHAMANI, Assia	000 s1 / 100 [3:08]
14 SIPOS, Babett	HUN	30 SAID ERRHAMANI, Assia	

27 SAID ERRHAMANI, Assia
000 s2 / 101 [4:00]
Pool C - Winner
Vainqueur / Sieger

POOL D

4 OBRADOVIC, Jovana	SRB	13 OBRADOVIC, Jovana	100 / 000 [2:00]
20 KULIK, Barbara	POL	23 OBRADOVIC, Jovana	100 / 000 [0:50]
12 VOLPE, Ombretta	ITA	14 BOKAREVA, Sofia	000 / 100 s1 [1:19]
28 BOKAREVA, Sofia	RUS	15 TOMA, Iliana	100 s1 / 000 s1 [1:18]
8 TOMA, Iliana	ROU	24 BABIC, Lucija	000 s2 / 100 s1 [3:07]
24 LUDVIK, Lia	SLO	16 BABIC, Lucija	100 / 002 [2:58]
16 BABIC, Lucija	CRO	32 MILIC, Kristina	

28 OBRADOVIC, Jovana
010 / 000 [4:10]
Pool D - Winner
Vainqueur / Sieger

OBRADOVIC, Jovana
000 / 100 [0:36]

1.

38 OBRADOVIC, Jovana
000 / 100 [0:47]

Results Résultat / Platzierungen

- OBRADOVIC, Jovana SRB
- OBRADOVIC, Anja SRB
- SAID ERRHAMANI, Assia FRA
- LISONI, Chiara ITA
- D ISANTO, Nicolle ITA
- BABIC, Lucija CRO
- MILIC, Mirjana MNE
- KUKHARUK, Hanna UKR

Repechage / Trostrunde

[A1] TONIOLO, Elisa	ITA	29 TONIOLO, Elisa	010 s1 / 000 [4:00]
[A2] STUMPP, Tarah	GER	[A3] MILIC, Mirjana	000 s1 / 001 [4:00]
[B1] KOKORIC, Marta	CRO	30 STOYANOVA, Iliana	000 / 100 [0:59]
[B2] STOYANOVA, Iliana	BUL	[B3] D ISANTO, Nicolle	000 / 100 [2:12]
[C1] SIPOS, Babett	HUN	31 KUKIC, Ivana	000 s3 / 000 s2 [4:00]
[C2] KUKIC, Ivana	BIH	[C3] KUKHARUK, Hanna	001 / 101 [2:10]
[D1] KULIK, Barbara	POL	32 KULIK, Barbara	101 / 000 s2 [1:17]
[D2] BOKAREVA, Sofia	RUS	[D3] BABIC, Lucija	000 s1 / 000 [4:00]

39 D ISANTO, Nicolle
000 s3 / 000 s1 [4:00]

[38] SAID ERRHAMANI, Assia

40 BABIC, Lucija
000 s2 / 000 [4:00]

[37] LISONI, Chiara

41 SAID ERRHAMANI, Assia
000 / 100 s1 [2:19]

3.

42 LISONI, Chiara
001 / 100 s1 [3:41]

3.



European Cup Cadets Zagreb 2015

Zagreb (CRO) 14-15 February 2015

-70 kg

25 Judoka

POOL A

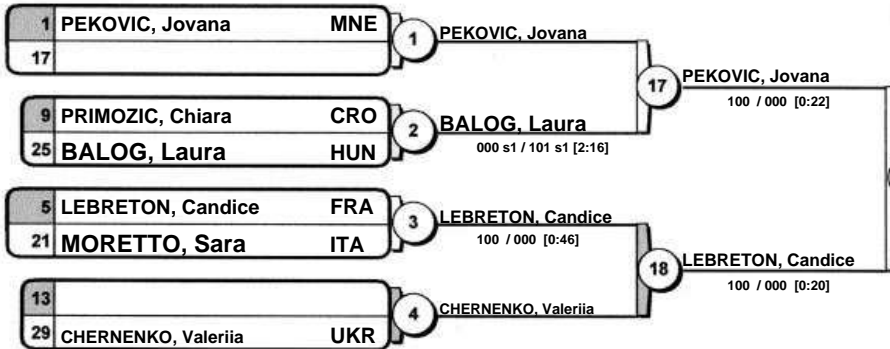

Pool A - Winner
Vainqueur / Sieger

POOL B



Pool B - Winner
Vainqueur / Sieger

POOL C

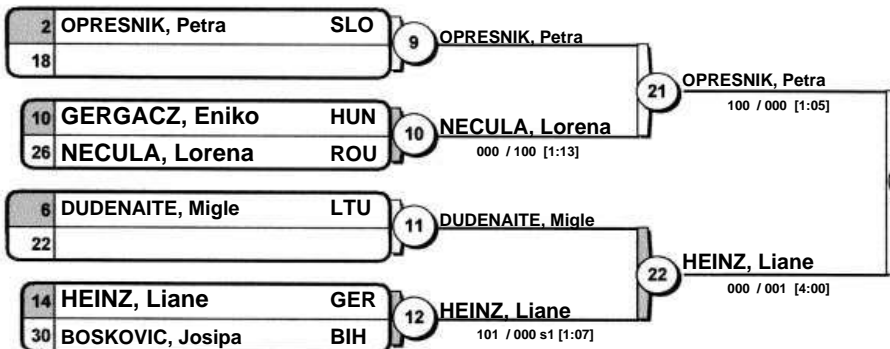

Pool C - Winner
Vainqueur / Sieger

POOL D

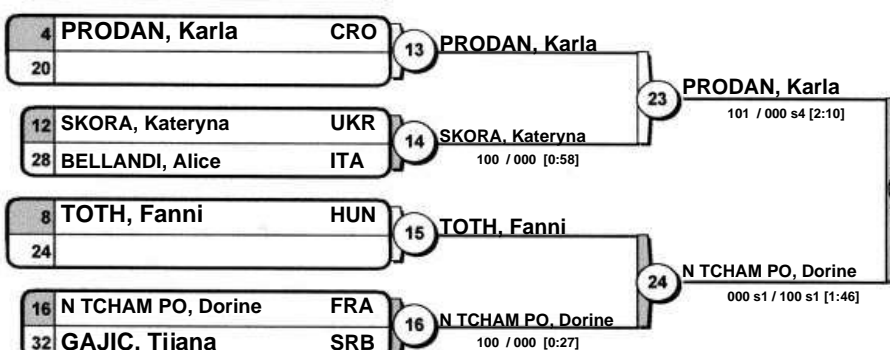

Pool D - Winner
Vainqueur / Sieger

PRODAN, Karla

1.

38 PRODAN, Karla

Results
Résultat / Platzierungen

1. PRODAN, Karla CRO
2. BORISOVA, Boryana BUL
3. OPRESNIK, Petra SLO
3. PEKOVIC, Jovana MNE
5. LEBRETON, Candice FRA
5. HEINZ, Liane GER
7. RADMILOVIC, Djurdjina SRB
7. SKORA, Kateryna UKR

Repechage / Trostrunde

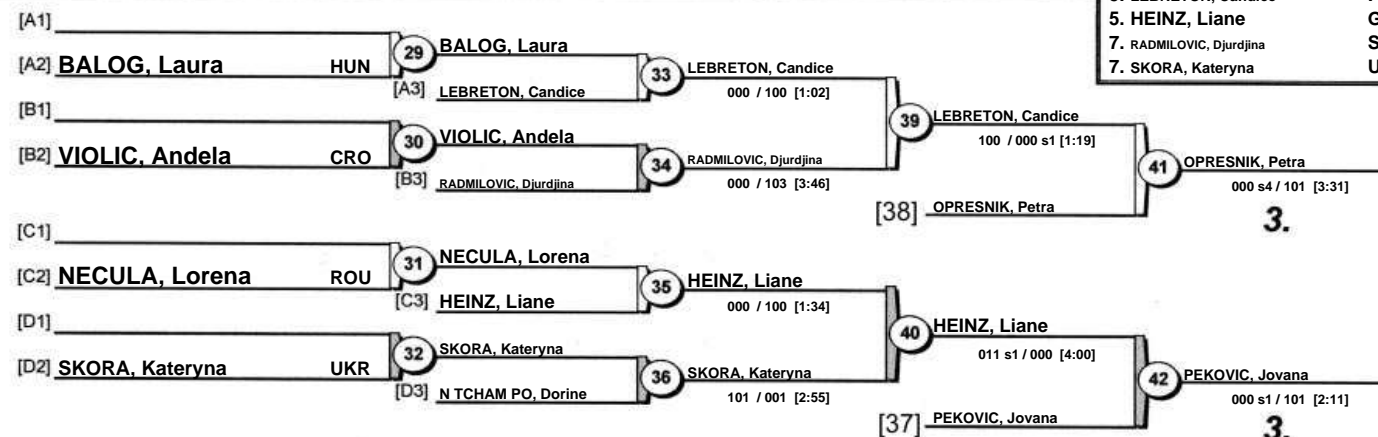

3.

3.



European Cup Cadets Zagreb 2015

Zagreb (CRO) 14-15 February 2015

+70 kg

12 Judoka

